

*product number*   *product name*   *product designation*   *supported product version*  
**10.752**   **CBA UP**   **Casambi Jalousieaktor UP**   **H1 F2.5**

*Dokument Version:* 20221014

## Manufacturer's address and contact details

Adress   **MTC maintronic GmbH**  
Carl-Zeiss-Straße 10  
D-97424 Schweinfurt/Germany

Contact details   E-Mail   [info@maintronic.com](mailto:info@maintronic.com)  
Web   [www.maintronic.com](http://www.maintronic.com)  
Phone   0049 9721 7766-0

# Table of Contents

<b>1. Notes to the instruction . CBA UP</b>	<b>3</b>
1.1 Applicable documents	3
1.2 Usage	3
1.3 Safety information	3
1.5 Used symbols	4
1.6 Storage	7
1.7 Warranty and liability	7
1.8 Service and support	7
1.9 Disposal	7
<b>2. Safety . CBA UP</b>	<b>8</b>
2.1 General safety information	8
2.2 Intended use	10
2.3 Not-intended use	11
<b>3. Functions . CBA UP</b>	<b>12</b>
3.1 Performance characteristics	12
3.2 Features	12
<b>4. Technical data . CBA UP</b>	<b>13</b>
<b>5. Installation . CBA UP</b>	<b>14</b>
5.1 Considerations and planning	14
5.2 Mechanical installation	15
5.3 Electrical installation	17
<b>6. Commissioning . CBA UP</b>	<b>20</b>
6.1 Operation with Casambi	20
6.2 Commissioning	20
6.3 Select an operating mode	22
6.4 Change operating mode	32
6.5 Calibration	34
<b>7. Operation . CBA UP</b>	<b>35</b>
7.1 Notes for operation	35
7.2 Sensors and parameters	38
7.3 Operation with app	39
7.4 Operation with Push-button input	41
7.5 Operation with Wireless switch	43
.....	45
7.6 Operation with Device button	47
7.7 Push-button mode	48
7.8 Programming timers	49
<b>8. Troubleshooting . CBA UP</b>	<b>51</b>
8.1 Failure causes and solutions	51
8.2 Unpair devices from network	51
<b>9. Service and maintenance . CBA UP</b>	<b>53</b>

# 1. Notes to the instruction . CBA UP

## 1.1 Applicable documents

This document contains all the necessary information for using this product.  
Please refer to this document in partial instructions (such as installation instructions).

## 1.2 Usage

This manual describes everything necessary for the safe and efficient use of the device. The manual is an integral part of the product and must be handed over to the end customer.  
Please note that earlier versions of the product may differ in programming, operation and behavior and may not support all the features described here.

Before installation, commissioning and operation, read this manual and pay attention to the warnings for safe handling, which are marked as follows:

## 1.3 Safety information

### DANGER



The signal word "DANGER" indicates an imminent danger. If not avoided, death or serious injury will result.

### WARNING



The signal word "WARNING" indicates a possibly imminent danger. If it is not avoided, death or very serious injuries may result.

### CAUTION



The signal word "CAUTION" indicates a possibly imminent danger. If it is not avoided, slight or minor injuries may result.

### ATTENTION

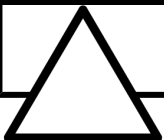









The signal word "CAUTION" indicates a situation that can lead to material damage. Either to the product itself or to other objects in the environment.





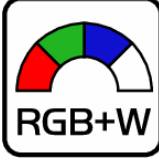



### NOTE

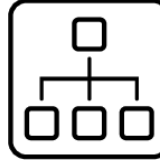



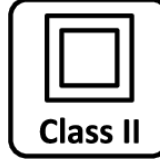

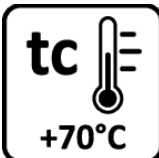
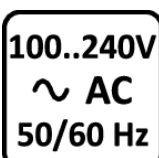

The signal word "NOTE" indicates tips and recommendations to help you get the most out of the product.

## 1.5 Used symbols









Icon	Description
	The number indicates the number of output channels of the device
	The number indicates the number of equipped push-button inputs
	Max. output current per channel
	Dimmed channel
	LED dimmer
	RGB+W color mixing
	Dims RLC loads R = resistive loads L = inductive loads (conventional transformers) C = capacitive loads (electronic transformers)
	Zero-cross switch - Device powers up or down by zero crossing of the sinewave
	Weight in gramm

Icon	Description
	Astro function - control scenes through sunrise and sunset
	Group devices - create groups for joint control
	Logical inverting of channels. e.g. for a blind up - down or CH1 and CH2
	Timer function - execute time-controlled automated functions
	Scene control - save individual fixed images as scenes or create a chaser with an animation
	Type of protection
	Protection class II - protection through double insulation
	Protection class III - protection through supplied from a separated extra-low-voltage
	Wireless protocol Casambi
	DALI protocol interface

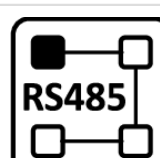
	Temperature ambient (ta)
	Temperature critical (tc)
	Powersupply AC - the voltage details either refer to a fixed voltage or a work ce e.g. 100 to 240 V AC
	Powersupply DC - the voltage details either refer to a fixed voltage or a working range e.g. +10 to 24 V DC
	Powersupply DC - battery possible
	Powersupply - powered from DALI
	The number indicates how much space (in TE) the device takes up on a DIN rail
	Flush mouted housing - in installation boxes or in devices of protection class II
	Installation housing - installation in ceiling, wall or luminaire

**NOTE**

 The symbols explained here show the technical data of the devices. These symbols can be found in the technical documentation of the respective device.

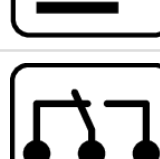
	DALI protocol interface with device type 6
	DMX protocol interface
	DMX protocol interface with RDM
	RS485 interface
	Push-button input on mains voltage 230V AC
	Push-button input
	Wireless push-button input
	Wireless controll
	Wireless controll with gateway / repeater function
	Rollers and blinds function
	changeover relay Number indicates the amount of relays

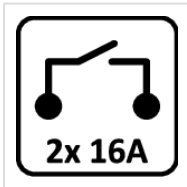
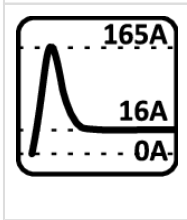
	<p>Switch Relay (normally open contact)</p> <p>Number indicates the amount of relays and 16A the switch current of the relay</p>
	<p>Relay with high inrush current - current peaks up to 165A for 20mS</p>

## 1.6 Storage

Electrical devices are stored constantly at 10 to 25 degrees Celsius in dry storage rooms.

The devices must be protected from dust, moisture, splashing and dripping water.

## 1.7 Warranty and liability



Dieses Handbuch wurde mit größtmöglicher Sorgfalt erstellt, es sind dennoch Fehler und Irrtümer nicht vollständig auszuschließen. Die Firma MTC maintronic GmbH übernimmt keinerlei Haftung für Personen- oder Sachschäden, die sich aus Fehlern oder Irrtümern in dieser Bedienungsanleitung herleiten oder durch Nichtbeachtung von Sicherheitshinweisen.

Die Rechte von eventuell genannten fremde Firmennamen, Marken, Warenzeichen oder Logos liegen bei den jeweiligen Eigentümern.

## 1.8 Service and support

If you need special support beyond the information provided here, contact your distributor or the address in the Manufacturer Contact section. [Herstellerkontakt](#).

## 1.9 Disposal

Waste disposal	
	<p>In accordance with European Directive 2002/96/EC (it`s) not longer usable electronic devices and defective or used batteries (European Directive 2006/66EG) must collected separately and disposed by an environmentally sound recycling.</p> <p>This symbol indicates that electrical and electronic equipment must be disposed of separately from normal waste at the end of its operational lifetime.</p>
	<p>Should these product are no longer be useable, the user is required by law to dispose of old appliances separately from their household waste e.g. at a local authority collection point or recycling center.</p>

## 2. Safety . CBA UP

### 2.1 General safety information

#### Qualified personnel

##### DANGER



The unit must only be installed and serviced by a proven electrician specialist, in accordance of all relevant regulations, safety and accident prevention directives of the country.

Be sure that the existing mains voltage corresponds with the specified operating voltage before operating the device.

Risk of electric shock. Do not operate the device without a cover. Even when switched off, voltage may be present at the outputs. When working on the device or connected loads, always disconnect the upstream fuse from the power supply.

Apply the "Five Safety Rules" (DIN VDE 0105, EN 50110):

1. Disconnect
2. Secure against being switched on again
3. Determine absence of voltage
4. Ground and short circuit
5. Cover or isolate nearby live parts

Only install the device in places with a good ventilation and without humidity or high temperatures. Do not expose the unit to rain or snow. Do not operate the unit near heat sources, e.g. radiators.

If any of the following occurs, do not operate the device without first checking it:

- if objects have fallen or liquid has been spilled into the unit.
- if the device has been exposed to rain.
- if the device does not operate normally or with altered characteristics. if the device has been dropped or has a broken housing.

For cleaning only use a dry, soft cloth, by no means liquids.

#### Working on electrical installations

##### WARNING



*Dangerous voltages in live installations, cables, plugs ...*

#### Device-specific notes

##### WARNING



*There is a risk of dangerous voltages being applied to the device (DALI, not SELV). If a person touches live parts, an electric shock can cause serious injury or even death.*

##### WARNING



For your own safety, read all instructions and information in this manual carefully before initial operation. Keep this manual for future reference.

The instructions are an integral part of the product and must be handed to the end customer.



All information and instructions in this manual must be observed completely and in detail. The manufacturer is not responsible for any direct or consequential damage that results from disregarding any information in this manual.

#### Waste disposal



In accordance with European Directive 2002/96/EC (it`s not longer usable electronic devices and defective or used batteries (European Directive 2006/66EG) must collected separately and disposed by an environmentally sound recycling.

This symbol indicates that electrical and electronic equipment must be disposed of separately from normal waste at the end of its operational lifetime.

Should these product are no longer be useable, the user is required by law to dispose of old appliances separately from their household waste e. g. at a local authority collection point or recycling center.

#### CE-marking



The devices comply with the EU directives applicable at the time they are placed on the market.

## 2.2 Intended use

Casambi-Jalousieaktor zur Steuerung von Rollo-, Jalousie-, Tor-, oder Markisenmotoren. Steuerung über Casambi Bluetooth per App oder lokale Bedienung über Standard-Jalousietaster.

Das Gerät unterstützt die Ansteuerung über **Tasteingang (Push-button-input)** und über **Casambi**.

Modul Version	Einbauort	Beschreibung
UP	Unterputz	für den Einbau in tiefe Schalterdosen oder Abzweigdosen

Das Gerät ist für Folgendes bestimmt:

- dem Betrieb gemäß den aufgeführten technischen Daten
- die Installation in trockenen Innenräumen
- die Nutzung mit den am Gerät vorhandenen Anschlussmöglichkeiten

### HINWEIS



Zur bestimmungsgemäßen Verwendung gehört auch die Einhaltung aller Angaben dieser Nutzerinformation.



Bitte beachten Sie, dass sich vorangegangene Versionen des Produktes in Programmierung, Bedienung und Verhalten unterscheiden können oder nicht alle hier beschriebenen Funktionen unterstützt werden!

1. Vergleichen Sie die Angabe der unterstützten Geräteversion dieses Handbuchs (dieser Dokumentation) mit der Angabe der Version auf dem Geräteaufkleber. Die Angabe zur Version findet sich auf dem Geräteaufkleber rechts unten:

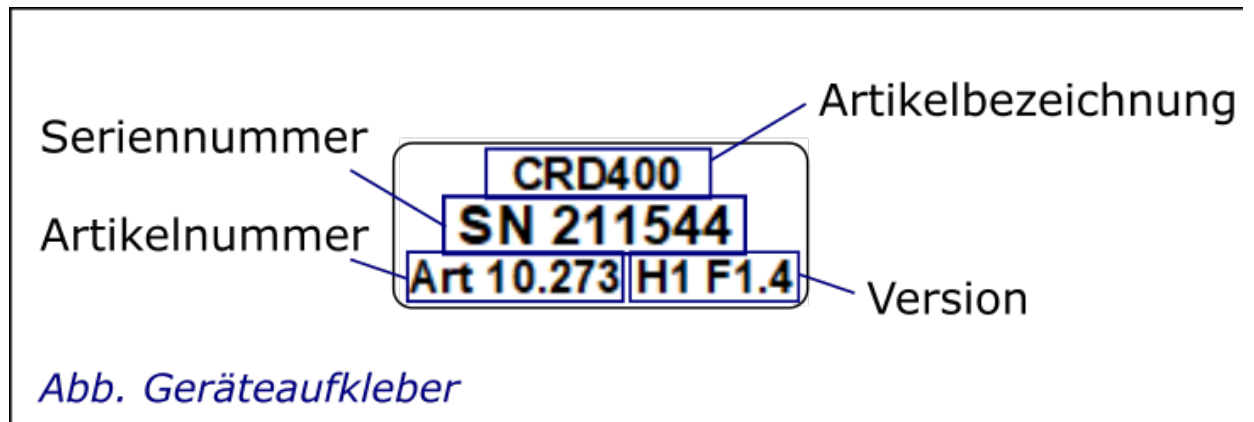

2. Stimmt die Version Ihres Gerätes nicht mit der im Handbuch unterstützten Version überein, beschaffen Sie sich das zugehörige Handbuch und verfahren nach der Anleitungen dort.

## 2.3 Not-intended use

Jede andere Verwendung gilt als bestimmungswidrig und kann zu Personen- und Sachschäden führen, insbesondere:

- eigenmächtige bauliche Veränderungen
- Reparaturen
- Einsatz im Außenbereich
- Einsatz in Nasszellen

MTC maintronic GmbH haftet nicht für Schäden, die durch bestimmungswidrige Verwendung des Geräts entstehen. Das Risiko hierfür trägt allein der Benutzer/Betreiber.

## 3. Functions . CBA UP

### 3.1 Performance characteristics

The device can be controlled via the Casambi app, available for iOS and Android. Another optional operation ist given by the push button input.

Casambi app automatically identifies the device and can be integrated into existing networks. All functions triggered by the buttons are individually configurable.









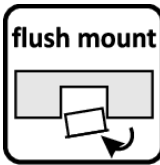

As soon as the device is added to your network, it can be operated. Groups can be formed, scenes and timers can be created.

You can find all Casambi app related help on the official Casambi support sites at: <https://support.casambi.com>.

These functions enable for example, to group 5 blinds on one side of the building and operate them together. In addition, automated up and down movements can also be programmed as a time-controlled scene.

For help with the configuration and operation of Casambi, please also refer to the official Casambi help at: <https://support.casambi.com/>.

### 3.2 Features

	 mains	 blind	 channels	 installation type
<b>Control</b>				
<b>Temp enviroment and electrical ...</b>			 Class II	 IP20
<b>Assembly end Shipping</b>	1 unit retail box 	weight 70g	Dimensions 46,5 x 70(51) x 30cm	

## 4. Technical data . CBA UP

Specification	CBA UP	Artikel Nr. 10.752
Power supply		130 ... 240V AC 50/60Hz
Switching type		2x interlocked changeover
Switching output		16A
Fuse		External fuse max 10A required
Power consumption	Standby	0,22W
	Switch operation	0,77W
Terminals and wiring	Phoenix push-in spring connection	0,5 - 1,5 mm <sup>2</sup> solid conductor
		0,5 - 0,75 mm <sup>2</sup> fine-stranded conductor with ferrule
	Stripping length	9 mm (+/- 0,5 mm)
Controls and indicators		DeviceButton, Status-LED
Protocol	Casambi	App available for Android and IOS
Alternate control	Casambi enabled Push-button inputs	2 x Inputs on mains voltage (L)
Environment	Type of protection	IP20
	Protection class	Class II
	Temperature ambient ta	0°...+50° Celsius
	Temperature critical tc	+70° Celsius
	Humidity	5 ... 80% non-condensing (n.c.)
Applied standards		CE
Design	Construction	Flush mounted housing
	Mounting	Flush-mounted or junction box
	Dimensions (height x width x depth) mm	46,5 x 70(51) x 30 (flaps can be removed)
	Ceiling installation	Ø 55mm
	Weight	0,070 kg
	Housing	Ultradid flame resistant, black
Customs	HS-Code/ TARIC-Number	85365080
Country of origin		Germany

## 5. Installation . CBA UP

### 5.1 Considerations and planning

A Casambi network is a mesh network and every participant (dimmer, switches, etc.) extend the reach of the network.

Casambi is based on the energy-saving Bluetooth 4.0 standard. If a module is nearby, all luminaires within range of this module can be controlled.

Bluetooth has a range of up to 20 m. Plan your network in such a way that the radio coverage of the modules is guaranteed with each other and no dead spots arise.

If there are gaps in the network or modules are positioned at the limit of the radio coverage, strange errors can sometimes occur.

## 5.2 Mechanical installation

### Dimensions

Flush-mounted housing for installation in switch boxes or junction boxes. Attachment with two eyelets, these can be removed for installation.

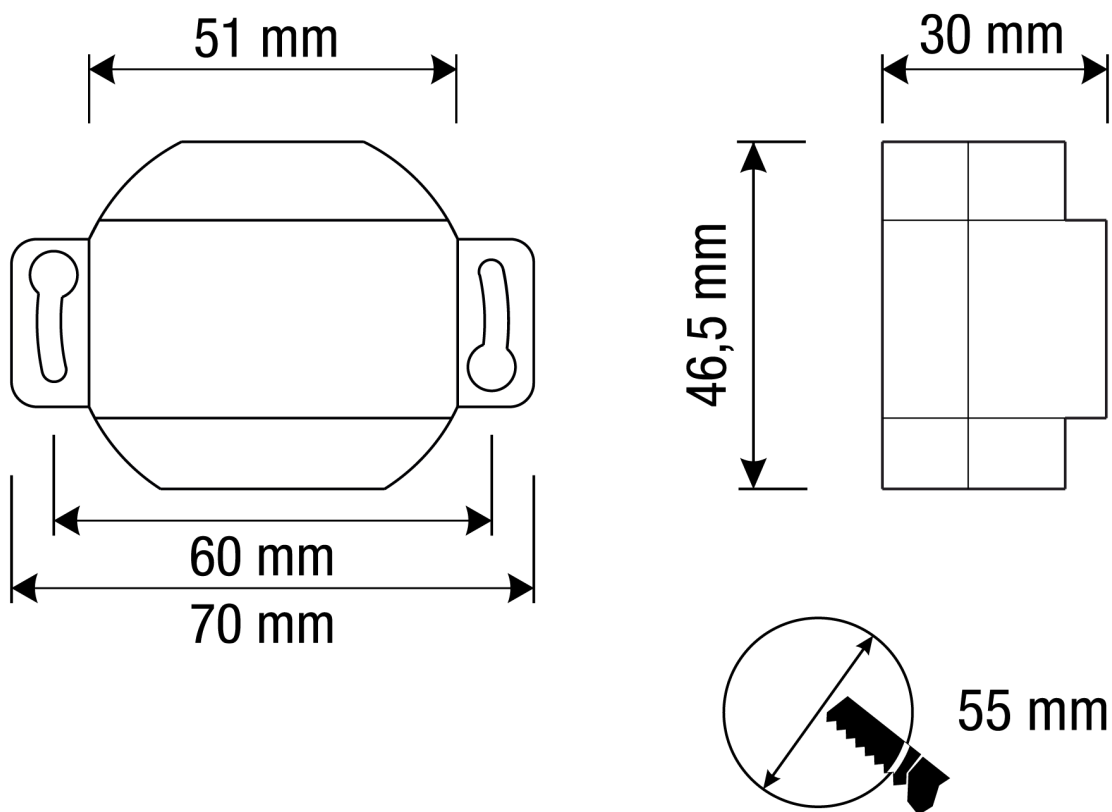

### Installation

Even if the device has tiny dimensions, a deep installation box (>60 mm) is highly recommended. Depending on which push-button is used, up to 30 mm of the available space must be deducted.

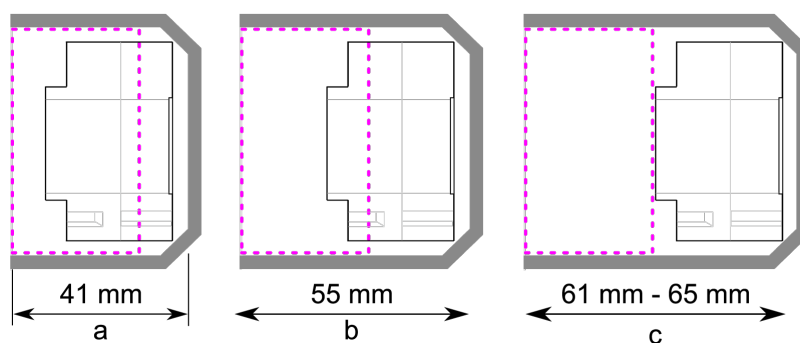

For installation in cavity or switch boxes, the eyelets needs to be removed. Install the device with labeling, LED and device button must point to the front.

Remove the eyelets and flip the device, install with labeling, LED and device-button faces forwards.

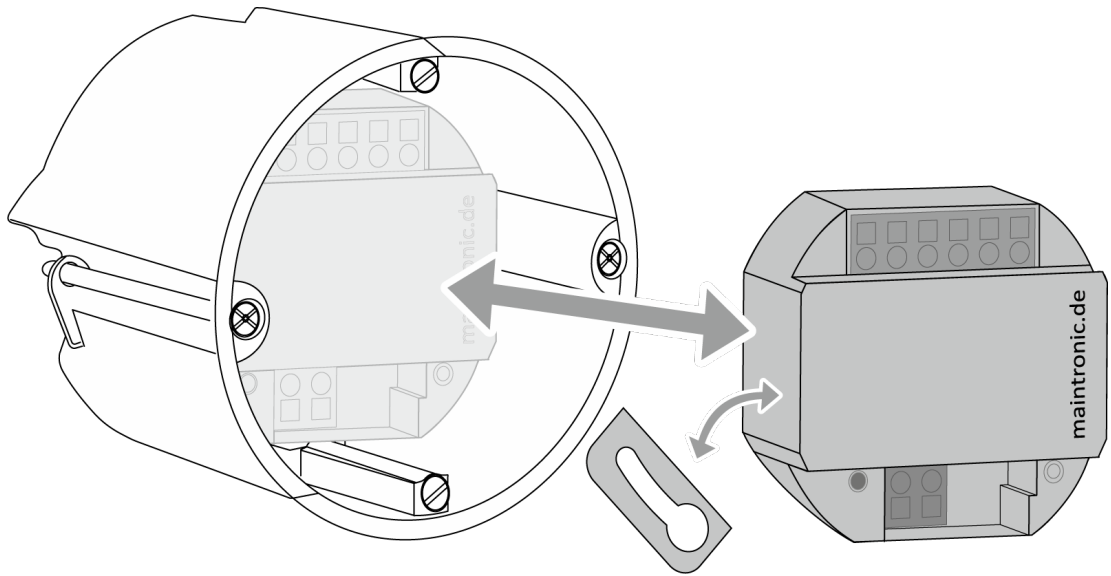



## 5.3 Electrical installation

### Terminals

1	N	Neutral conductor
2	N	Neutral conductor
3	L	Input mains, phase 230V AC
4	U ▲	Relay Drive Up
5	D ▼	Relay Drive Down
6	L'	Switched Output, phase 230V AC
7	T1	Push-button input T1
8	T2	Push-button input T2

#### NOTE



The relay outputs are mutually blocked to ensure that only one path is active at a time (motor protection).

#### WARNING



Please note that mains voltage is always applied to the pin of the switched phase L' (pin 6) as long as no active movement is carried out via the Casambi control level.

### Connection diagram

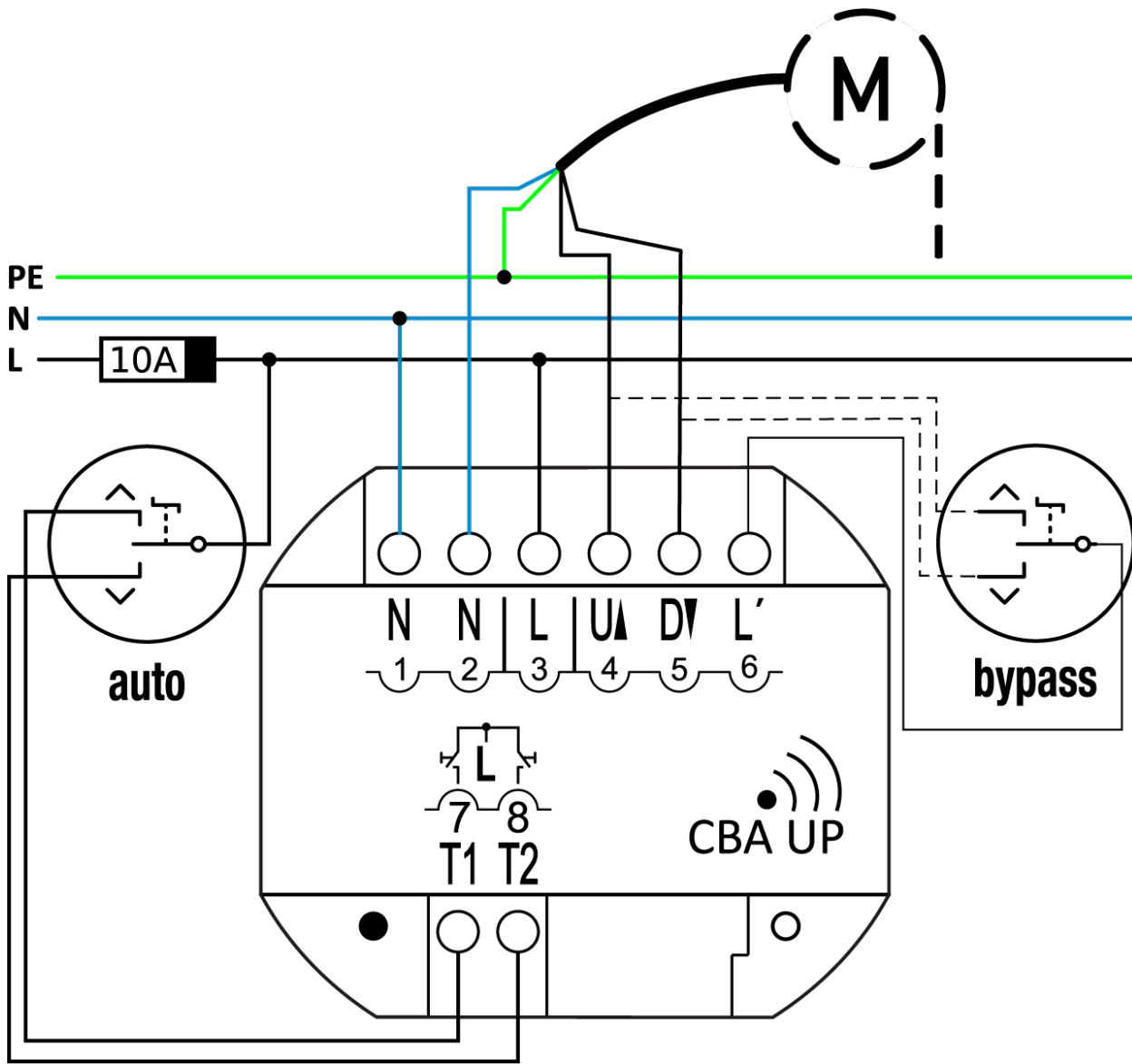

## Wiring

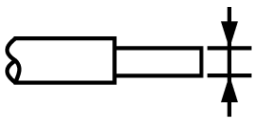
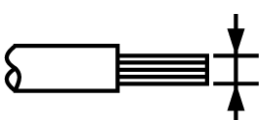
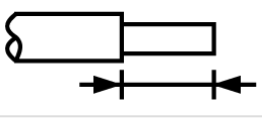
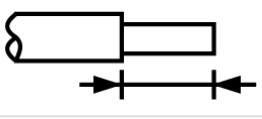
	0,5...1,5mm <sup>2</sup> Solid conductor
	0,5...1,5mm <sup>2</sup> Fine-stranded conductor
	0,5...0,75mm <sup>2</sup> Fine-stranded conductor with ferrule
	8mm

## Operating elements

### Controls

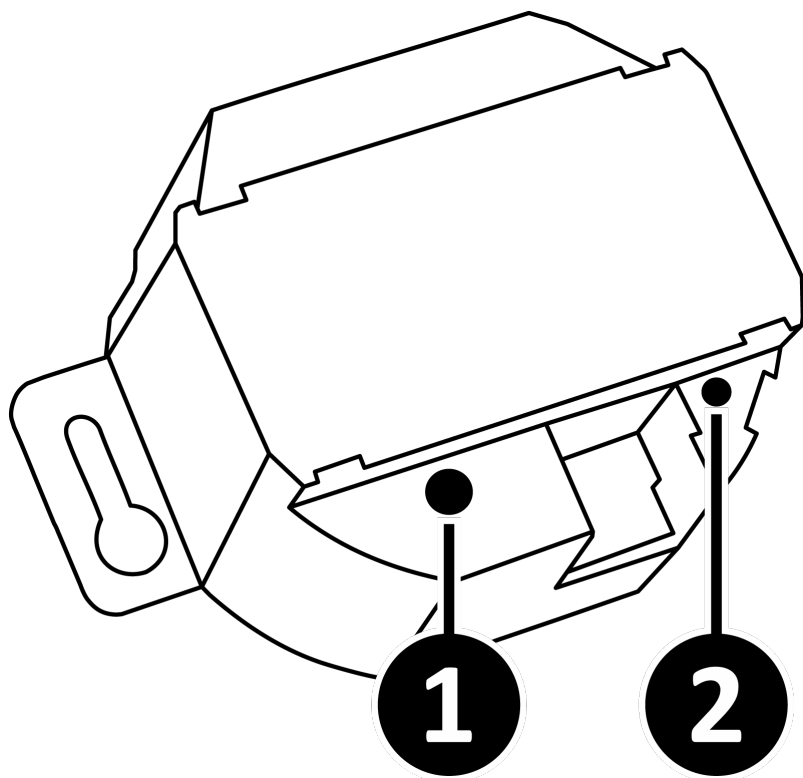

1	Device button
2	Status LED

## 6. Commissioning . CBA UP

### 6.1 Operation with Casambi

The device can be controlled via the Casambi app, available for iOS and Android. Another optional operation ist given by the push button input.

Casambi app automatically identifies the device and can be integrated into existing networks. All functions triggered by the buttons are individually configurable.

As soon as the device is added to your network, it can be operated. Groups can be formed, scenes and timers can be created.

You can find all Casambi app related help on the official Casambi support sites at: <https://support.casambi.com>.

### 6.2 Commissioning

To make sure that the functionality of the device is up to date, first of all you have to check if a new firmware is available.

#### Update firmware

1. Open Casambi App
2. Go to nearby devices
3. Scroll down
4. Check for updates
5. If an update is available, please install

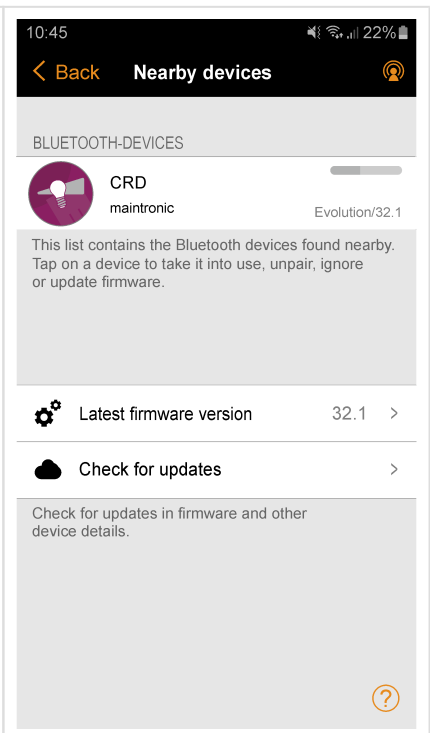

## Add a device to a network

Casambi App automatically identifies the device and can be integrated into existing networks. All functions triggered by the buttons are individually configurable.

The following steps are necessary for this purpose:

1. Open Casambi App
2. Choose existing network or create a new network
3. Go to nearby devices
4. Add found maintronic device to a network

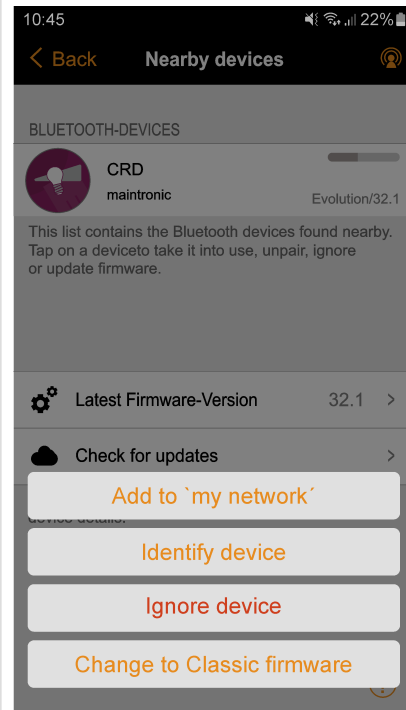

## 6.3 Select an operating mode









### Select application profiles

The device has different operating modes (so-called Casambi profiles), with the profiles the functionality and the parameters of the device are determined.

Before programming, a Casambi profile must be selected (by default the profile - CBA Blind + Buttons is set).

Select a suitable profile for your application:

### Application profiles listing

Fixture ID	Icon	Profile name	Control name	Function	Control type
19473		CBA Blind	Position Angle	Position Slat angle	Slider (0% - 100%) Slider (0% - 100%)
18445		CBA Blind + Buttons	Position Angle Up Down Angle	Position Slat angle Single trip Up Single trip Down Slat angle	Slider (0% - 100%) Slider (0% - 100%) ON/OFF Toggle ON/OFF Toggle Push Button
24843		CBA Blind + Buttons + Group	Position Angle Up Down Angle Master	Position Slat angle Single trip Up Single trip Down Slat angle Group Master Function	Slider (0% - 100%) Slider (0% - 100%) ON/OFF Toggle ON/OFF Toggle Push Button ON/OFF Toggle
19474		CBA Buttons	Up Down Function A Function B	Single trip Up Single trip Down Function for the button A Function for the button B	ON/OFF Toggle ON/OFF Toggle Push Button Push Button
24872		CBA Buttons + Group	Up Down Function A Function B Master	Single trip Up Single trip Down Function for the button A Function for the button B Group Master Function	ON/OFF Toggle ON/OFF Toggle Push Button Push Button ON/OFF Toggle
19476		CBA Shutter	Position	Position	Slider (0% - 100%)
19477		CBA Shutter + Buttons	Position Up Down	Position Single trip Up Single trip Down	Slider (0% - 100%) ON/OFF Toggle ON/OFF Toggle
24873		CBA Shutter + Buttons + Group	Position Up Down Master	Position Single trip Up Single trip Down Group Master Function	Slider (0% - 100%) ON/OFF Toggle ON/OFF Toggle ON/OFF Toggle

## Profiles for Blinds

<b>CBA Blind</b>	Operation via app drive blind to absolute position (Slider) adjust the Slat angle (Slider)
<b>CBA Blind + Buttons</b>	same as CBA Blind + <a href="#">Integration of external buttons and use of scenes</a>
<b>CBA Blind + Buttons + Group</b>	same as CBA Blind + Buttons + <a href="#">Operate several CBA UP together in a group</a>

## Profiles für Roller Blinds

<b>CBA Shutter</b>	Operation via app drive roller blind to absolute position (Slider)
<b>CBA Shutter + Buttons</b>	same as CBA Shutter + <a href="#">Integration of external buttons and use of scenes</a>
<b>CBA Shutter + Buttons + Group</b>	same as CBA Blind + Shutter + <a href="#">Operate several CBA UP together in a group</a>

## Special profiles

<b>CBA Buttons</b>	Operation via app only via Toggle Switch and button <a href="#">The functions of the two push buttons can be set.</a>
<b>CBA Buttons + Group</b>	same as CBA Buttons + <a href="#">Operate several CBA UP together in a group</a>

## Casambi Profile - CBA Blind - Fixture ID 19473

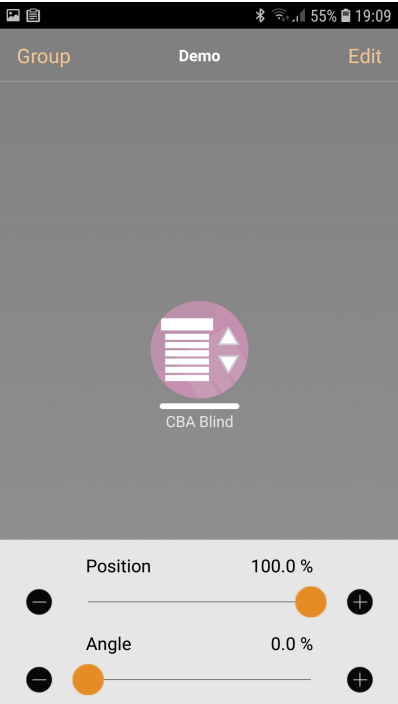
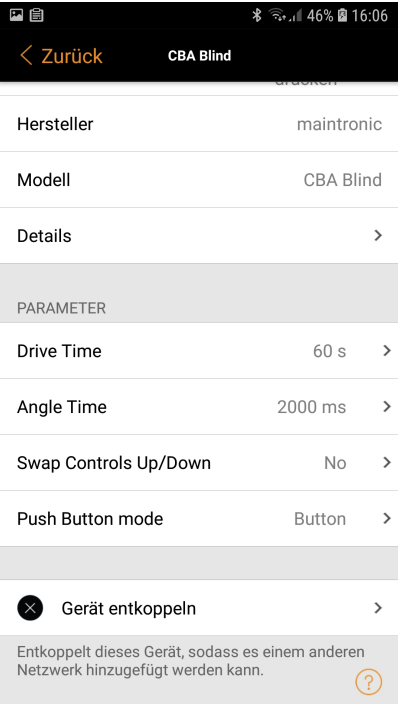
App Icon	Controls	Parameter
		

### Application

Blind with pure slider operation, one slider each for position and louvre angle (angle).

#### Info

The fixture "CBA Blind" has no additional controls for control via external buttons or scenes. For this, the fixture "CBA Blind + Buttons" ID 18445 or "CBA Blind + Buttons + Group" ID 24843 would have to be used.

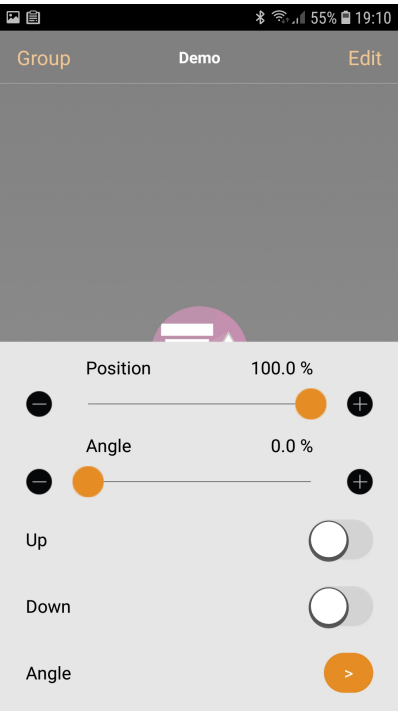
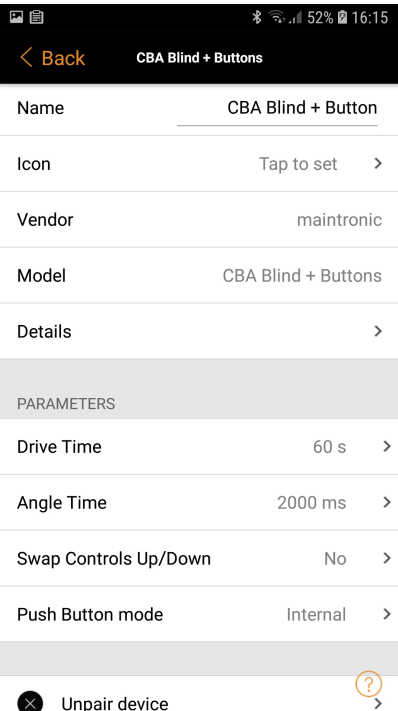

## Casambi Profile - CBA Blind + Buttons - Fixture ID 18445

App Icon	Controls	Parameter
		

### Application

Venetian blind with slider operation via app

+ Toggle switch for scene programming and button operation.

#### **i** Info

In addition to the two sliders for position and angle, the fixture "CBA Blind + Buttons" has a toggle switch for each direction of travel and a push button for the slat adjustment.

The switches and buttons can be used to program scenes when automated drives are to be used.

## Casambi Profile - CBA Blind + Buttons + Group - Fixture ID 24843

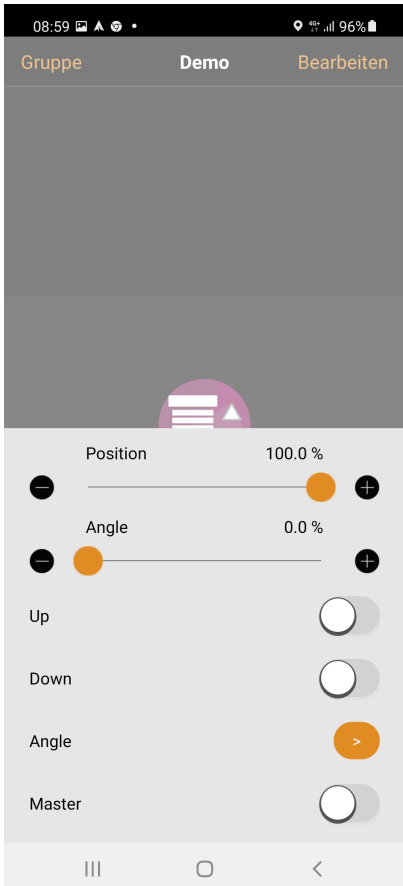
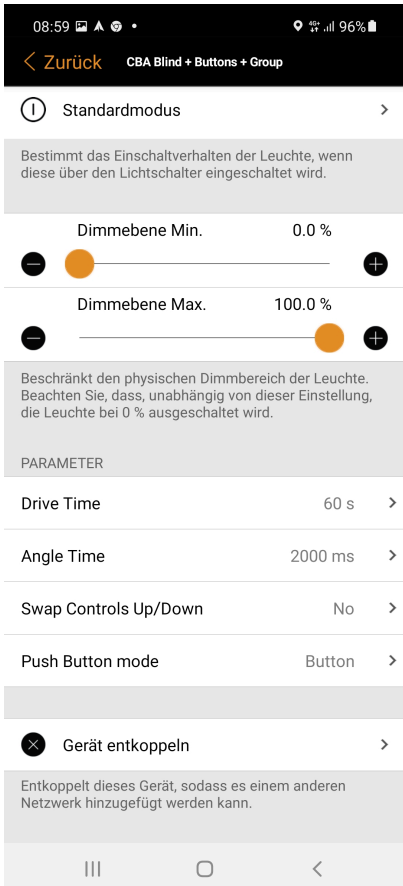
App Icon	Controls	Parameter
		

### Application

Venetian blind with slider operation via app

- + Toggle switch for scene programming and button operation.
- + Additional group function with master switch.

#### Info

In addition to the two sliders for position and angle, the fixture "CBA Blind + Buttons + Group" has a toggle switch for each direction of travel, a push button for the lamella adjustment, and a master switch (toggle switch) for a group function.

The switches and buttons can be used to program scenes when automated drives are to be used.

## Casambi Profile - CBA Shutter - Fixture ID 19476

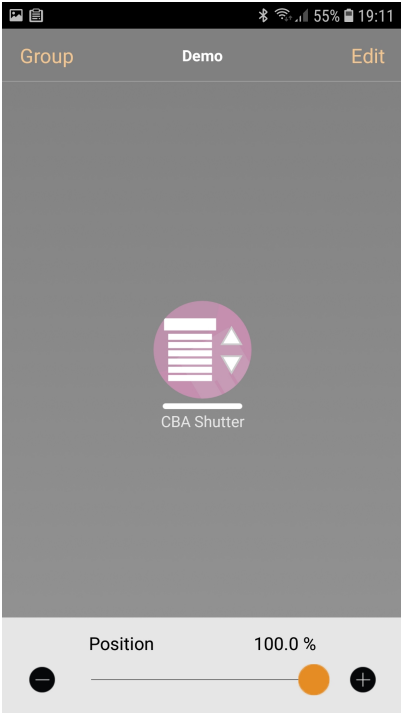
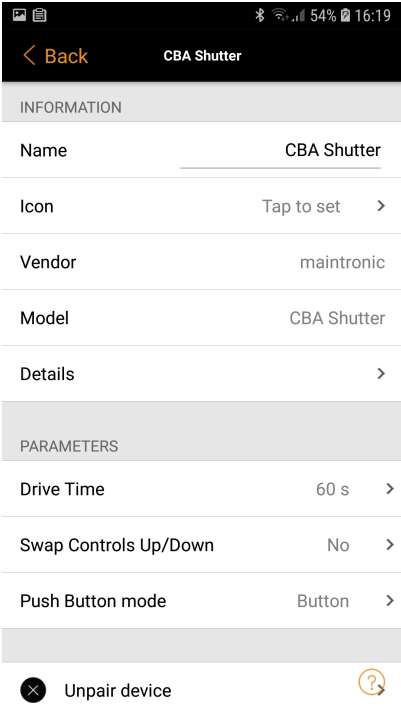
App Icon	Controls	Parameter
		

### Application

Roller blind with pure slider operation, a single slider for position.



#### Info

The fixture "CBA Shutter" has no additional controls for control via external buttons or scenes.

For this, the fixture "CBA Shutter + Buttons" ID 19477 or "CBA Shutter + Buttons + Group" ID 24873 would have to be used.

## Casambi Profile - CBA Shutter + Buttons - Fixture ID 19477

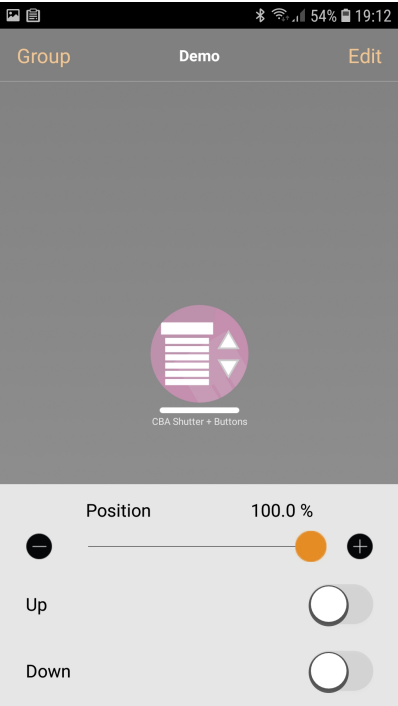
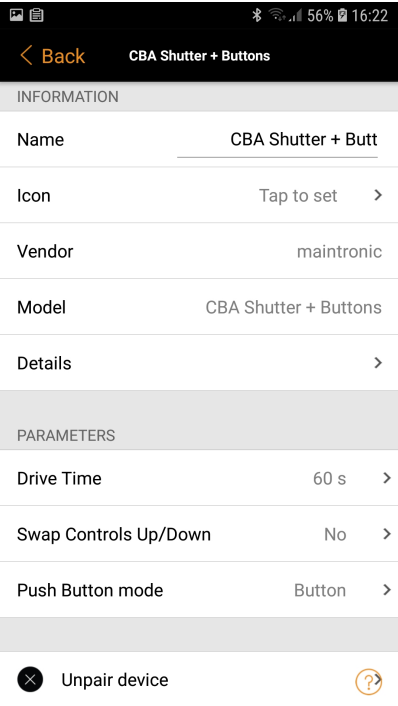
App Icon	Controls	Parameter
		

### Application

Roller blinds with slider operation via app

+ Toggle switch for scene programming and button operation.

#### **i** Info

In addition to the slider for position, the fixture "CBA Shutter + Buttons" has a toggle switch for each direction of travel. The switches and buttons can be used to program scenes when automated drives are to be used.

## Casambi Profile - CBA Shutter + Buttons + Group - Fixture ID 24873

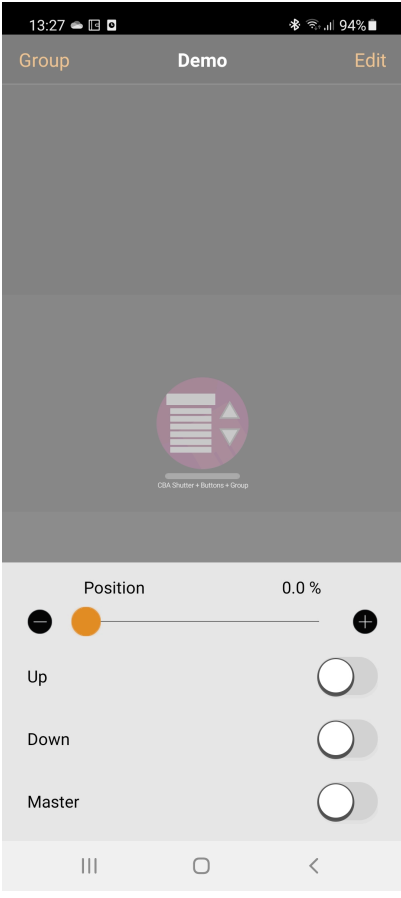
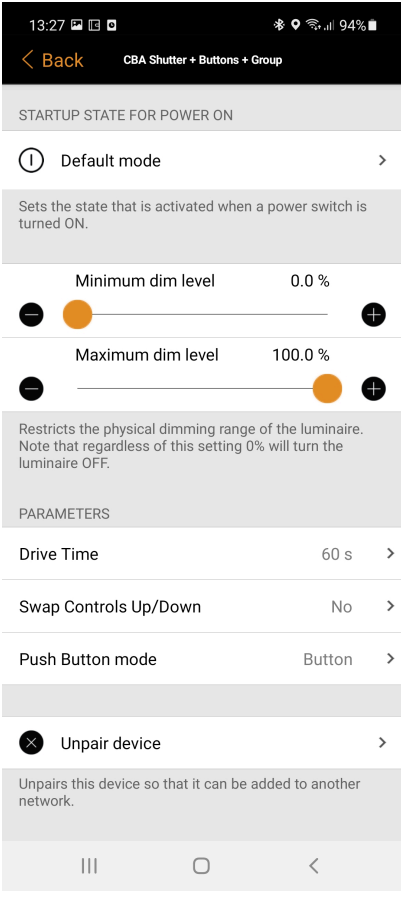
App Icon	Controls	Parameter
		

### Application

Roller blinds with slider operation via app

+ Toggle switch for scene programming and button operation.

+ Additional group function with master switch.

#### **i** Info

In addition to the slider for position, the fixture "CBA Shutter + Buttons + Group" has a toggle switch for each direction of travel and a master switch (toggle switch) for a group function.

The switches and buttons can be used to program scenes when automated drives are to be used.

## Casambi Profile - CBA Buttons - Fixture ID 19474

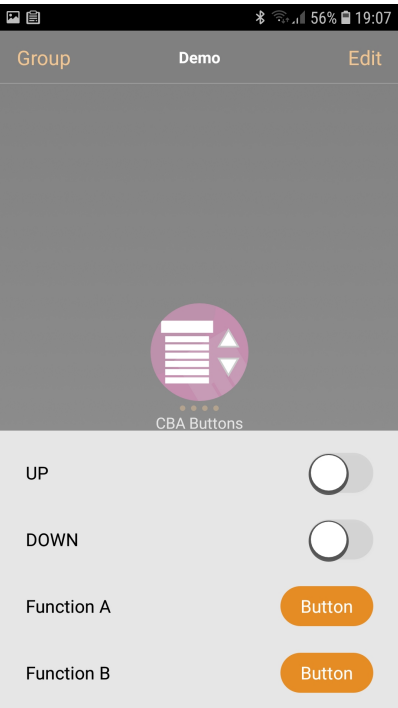
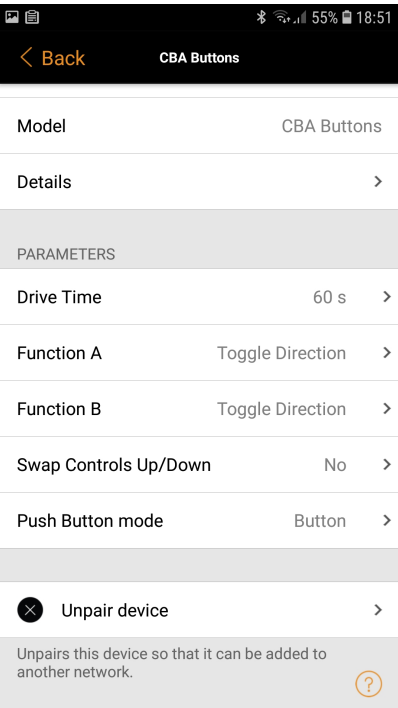
App Icon	Bedienelemente	Parameter
		

### Application

Push button operation without slider function

Possibility of switching (driving till the end) and buttons (press = drive, release = stop)

## Casambi Profile - CBA Buttons + Group - Fixture ID 24872

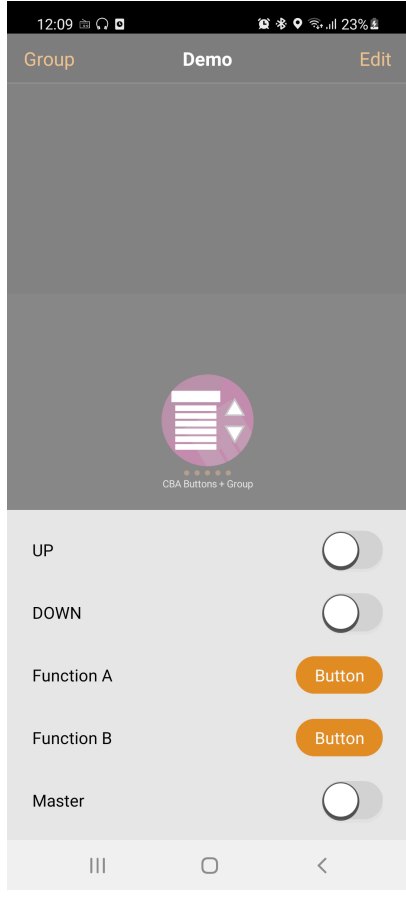
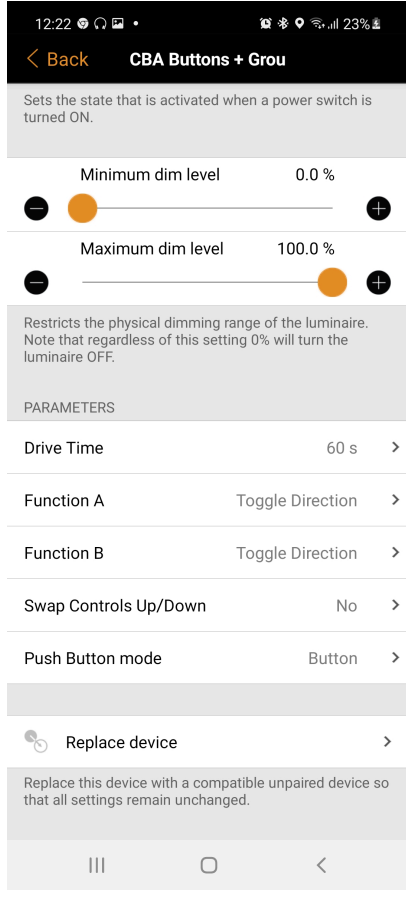
App Icon	Bedienelemente	Parameter
		

### Application

Push button operation without slider function  
 Possibility of switching (driving till the end) and buttons (press = drive, release = stop)  
 + Additional group function with master switch.

## 6.4 Change operating mode

The device has different operating modes (so-called Casambi profiles), with the profiles the functionality and the parameters are determined.

In order to select a specific operation mode, a Casambi profile must be selected via the Casambi app when teaching the device.

### Preparation

Device must be unpaired:

1. Open Casambi App and select „... More“
2. Open "Nearby Devices"

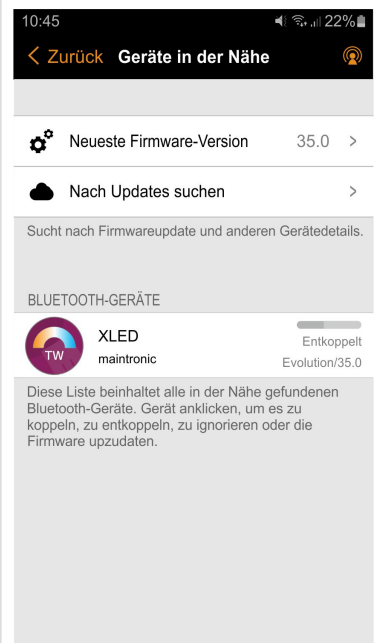

### Change Profile

1. Tap on the desired device
2. Select "Change Profile"

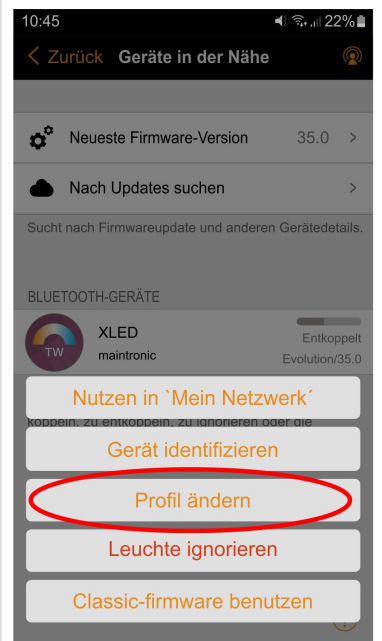



### Select desired operating mode (Casambi Profile)

For more information about the operating modes, refer to the manual in the "Commissioning" section.

1. Select a desired profile from the list provided
2. Tap on the desired profile
3. Select "Start Update"

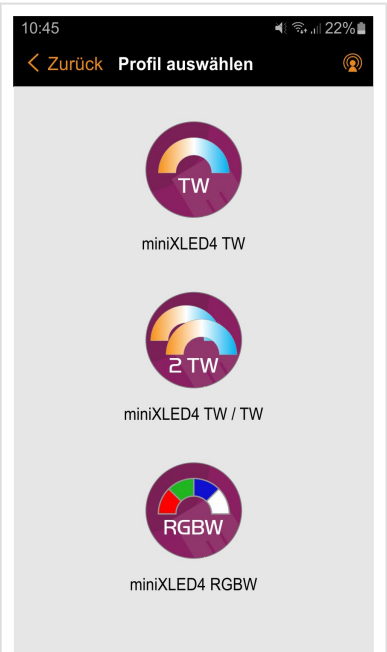

### Add the device to a network

1. Wait for the update to complete successfully
2. Select "Use in my network"
3. Device is now connected to your network

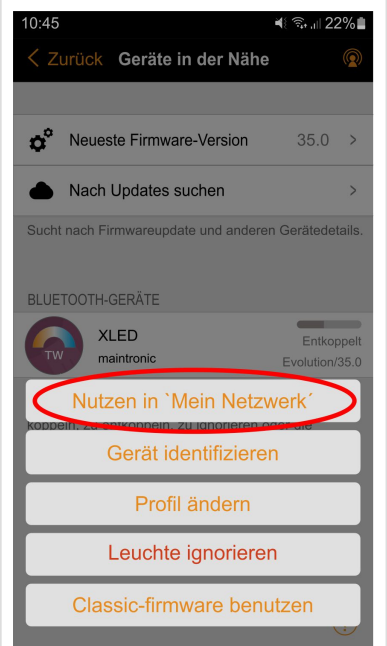

## 6.5 Calibration

### Perform calibration drive (Drive time)

To ensure proper operation, a calibration drive must be performed during initial startup. Once the device is added into a Casambi network, a calibration can be performed.

1. Therefore, run a complete cycle (0% fully open to 100% fully closed) and measure the "Drive Time".
2. In order to take into effect deviations in the travel time from bottom to top, the cycle (from 100% completely closed to 0% completely open) can be measured again.
3. Enter the measured time plus approx. 1 second (as a buffer) in the device settings under parameter „Drive Time“.
4. After changing the drive time, a complete drive (0% fully open - 100% fully closed) needs to be completed again.

### Setting the slat position (Angle time)

The „Angle Time“ is the aperture angle of the blind slats, this time must be measured and set in the parameters

1. Move the blind up a little until the slats are in the upper position.
2. Now move the blind downwards and stop the time until the slats are closed.
3. Set the measured time in ms in the parameters under „Angle Time“.

### Set drive direction

If the drive direction is not correct, the parameter „Swap Controls Up/Down“ can be used to swap the direction.

# 7. Operation . CBA UP

## 7.1 Notes for operation

There are different methods to operate the blind actuator.

### Driving with "Drive Time"

When driving with an adjusted "Drive Time", a single pulse (e.g. pressing a button or starting a time-controlled scene) is triggered, which causes the blind / roller blind etc. to move once to open position 0% or end position (closed) 100%.

This travel time is set via the "Drive Time" parameter and stored in the device.

### Driving to a specific position

With one trip to an absolute position, any horizontal position can be approached. The specific position is controlled by a slider (from 0% - UT 100%), which determines the status of the connected blind / roller blind etc.

### Slat adjustment

The angle of the slats can be adjusted via the slider "angle" (only available for fixtures with blinds). This slat position is stored during a travel to a certain position and the set value is automatically set again after reaching the set position.

For example, if the blind is only to be moved down a little bit and the slats are at 5%. Then, after reaching the target position, the slats are set back to 5%.

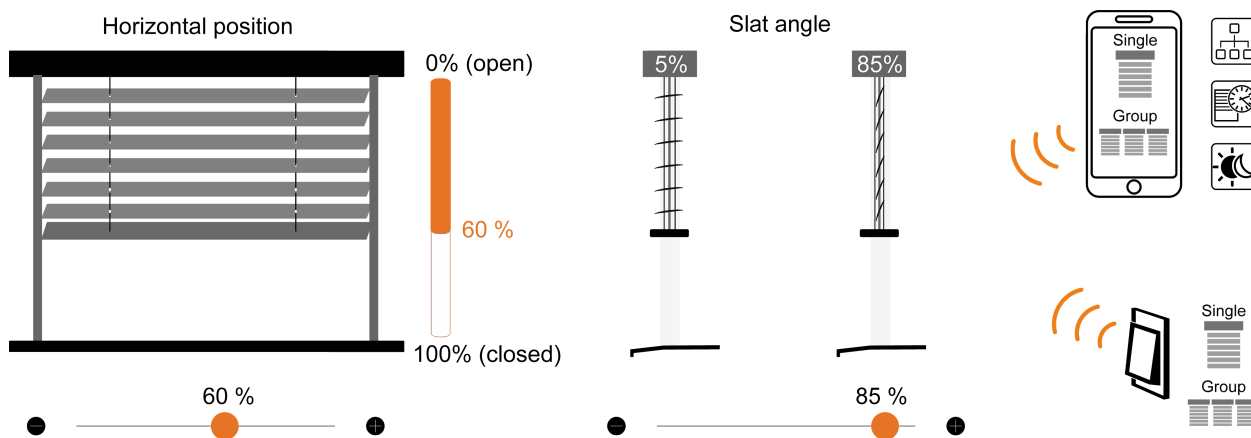

## Group controlling

For group controlling of multiple blind actuators in a group, one blind actuator of the group is configured as the master and must use one of the following fixtures:

Fixture	Name
24843	CBA Blind + Buttons + Group
24873	CBA Shutter + Buttons + Group
24872	CBA Buttons + Group

- Set one of the above-mentioned "Group" fixtures on the device which shall be configured as master,  
on all other devices no profile with the addition "Group" should be used
- Couple all desired blind actuators with a Casambi network
- Perform a calibration (reference run measure time - see instructions 6.5)
- Set Drive Time and Angle Time manually in the parameters of each device
- Combine all desired blind actuators together in a Casambi group

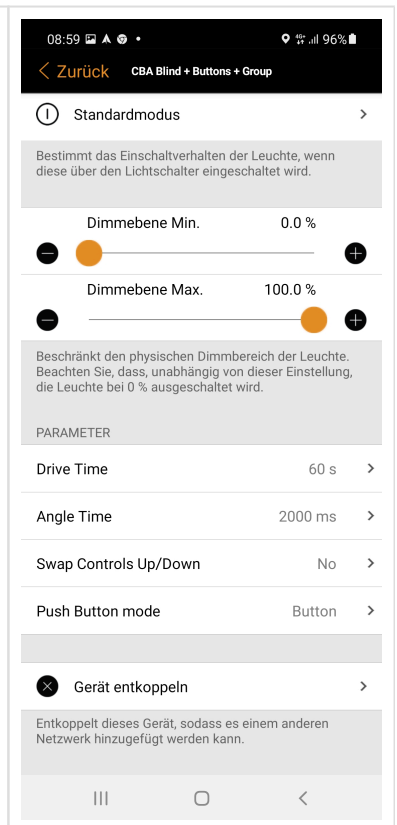

- Within the master device from the group, the toggle switch "Master" must be activated (switched)
- The controls "Up", "Down", and "Angle" of the master now control the entire group

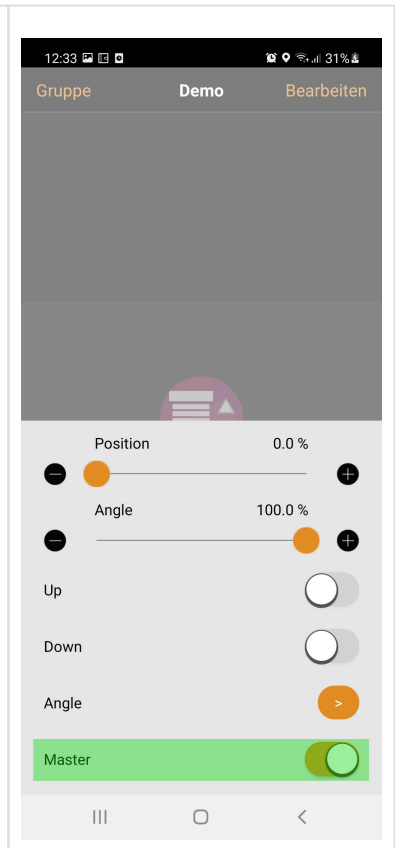

## Individual operation of the master via app

In order to drive the connected blind of the master device individually via app, the toggle switch "Master" must first be deactivated.

After that, the individual blind can be operated as usual.

## 7.2 Sensors and parameters

### NOTE



In the Casambi world they are the terms **sensors**, **parameters** and **information**. Each of the terms stands for a specific type of value.

Here is the explanation:

Name	Meaning	Examples	Type
<b>Sensors</b>	display static values or technical-physical values of the environment	Consumption / Number of switching cycles	read only
<b>Parameters</b>	settings to achieve the desired functions or behavior	State after switching on: last value	writable
<b>Information</b>	show values like manufacturer, model, or even detailed operating states of the device	RSSI: 78 dBm (radio reception quality)	read only



### Parameter

Parameter Designation	Description	Values	Notes	Default
Drive Time	Drive time for a passage of the blind up or down	0 ... 255s	Seconds	60s Default
Angle Time	Drive time for slat adjustment	0 ... 65535ms	Milliseconds	2000ms Default
Function A	Function for the push-button input T1	Not in Use Blind Up Blind Down Toggle direction	Not used Roller blind▲ Up Roller blind▼ Down ▲ .. Stop .. ▼ .. Stop Reverse direction	Toggle Direction
Function B	Function for the push-button input T2	Blind Up with time Blind Down with time Toggle direction with time	Roller blind▲ Up with time Roller blind▼ Down with time ▲ (t) Stop .. ▼ (t) Stop Reverse direction by time	Toggle Direction
Swap Controls Up/Down	Logical inversion of the direction of drive	No   Yes	Reverse direction of drive	No
Push Button mode	Behavior of keystroke gears	Button Casambi Group Button Switch Group Switch		Casambi

## 7.3 Operation with app

In the Casambi app, there are various controls for the devices.

### Slider

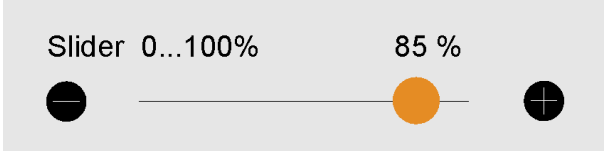
<p>With a slider you can adjust the brightness of a dimmer (from 0 ... 100%) and in the case of a blind actuator, the position of the roller blind/blind from completely open (0%) to completely closed (100%)</p>	 <p>Dimmer 45 %</p>
<p>The position of the slider can be controlled via the controls</p>	 <p>decrease or increase</p>
<p>and infinitely variable adjustment via the handle</p>	 <p>Slider 0...100% 85 %</p>

### Toggle switch

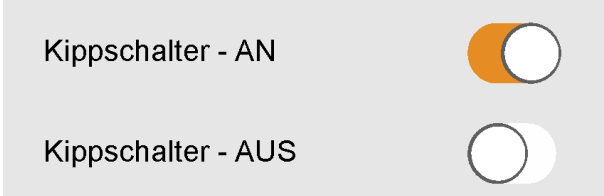
<p>A toggle switch in the app acts like a conventional Switch and has two positions</p>	 <p>ON and OFF</p>
<p>The switch remains in its position until a new switching command comes</p>	 <p>Kippschalter - AN Kippschalter - AUS</p>

## Button

A button has no fixed position but is only active as long as the button is held.

Taster





## 7.4 Operation with Push-button input

The device is equipped with two pushbutton inputs T1 and T2 (pin 7, 8), to which pushbuttons with mains potential can be connected. One push button has the same priority as the Casambi App, the last one wins. Note that the pushbutton inputs must be connected against phase (L).

All wiring and buttons must be insulated for the maximum supply voltage. After installation, pay attention to the appropriate touch protection. All buttons of the well-known switch manufacturers are suitable.

### Function switch

The key gears can be individually assigned functions.  
The following steps are necessary:

1. Open the Casambi app and select "... More"
2. Open item "Switch"
3. Choose your maintronic module with keystroke gears
4. Scroll down to the item "Button"
5. As an example, program buttons with single function.
  - a. Controls select a luminaire (default)
  - b. Tap on "luminaire"
  - c. Select your desired device

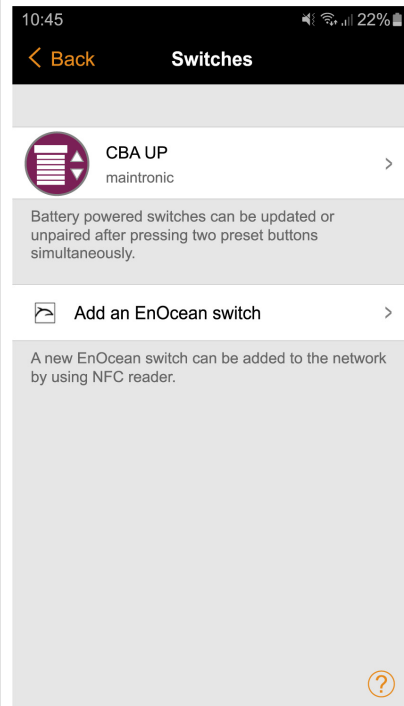

### Configure a button for a device

By default, the button is configured to itself.  
If you want to control a different device or scene, do the following:

1. Execute points 1-5 from above
2. Select the item "Controls a luminaire"
3. Select "Controls an element"
4. Select "Element"
5. Select the desired element

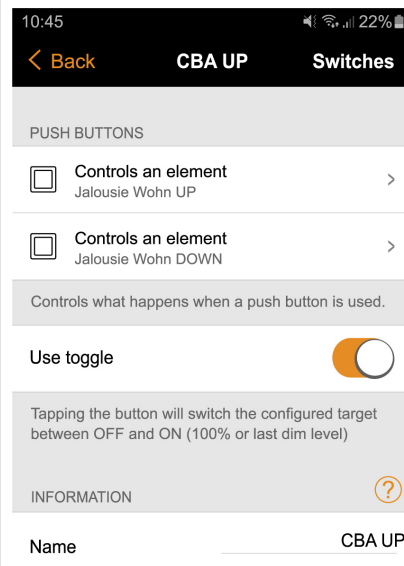

## NOTE



The function of the push-button style is defined via a parameter in the app.

### Local group runs via remote control (T1/T2):

In the parameter settings of the master, the "push-button mode" must be set to "Group Button" or "Group Switch", then the keystroke gears (T1/T2) of the device react to the group.

PARAMETER	
Drive Time	50 s >
Function A	Toggle Direction >
Function B	Toggle Direction >
Swap Controls Up/Down	No >
Push Button mode	Button >
Button	0 ✓
Casambi	1
Group Button	2
Switch	3
Group Switch	4

### Local single runs via remote switch (T1/T2):

In the parameter settings of the master, the "push-button mode" must be set to "Button" or "Switch", then the keystroke gears of the device react directly to the device.

PARAMETER	
Drive Time	50 s >
Function A	Toggle Direction >
Function B	Toggle Direction >
Swap Controls Up/Down	No >
Push Button mode	Button >
Button	0 ✓
Casambi	1
Group Button	2
Switch	3
Group Switch	4

## 7.5 Operation with Wireless switch

### Drive a group with a wireless switch:

- Combine desired devices together in a group
- Toggle switch "Master" must be active
- Select the BLE wireless switch under the "Switch" function
- Controls an element - here the "Up" or "Down" toggle switch of the master must be used
- Then you have a button for a run "Up" or "Down"
- Proceed the same way for the opposite direction

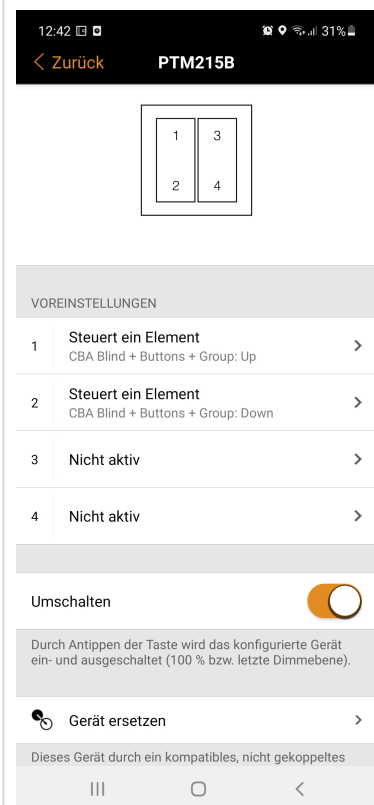
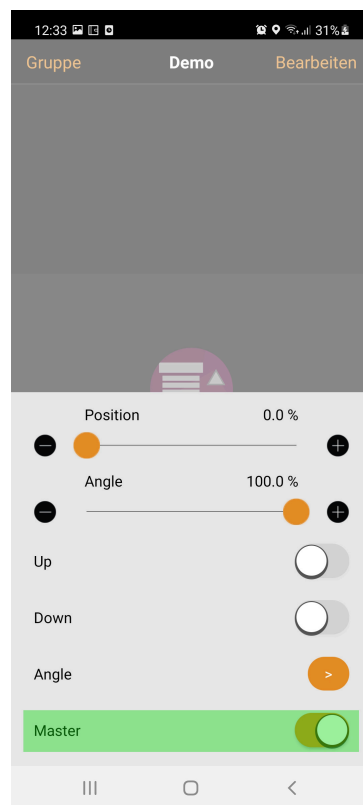

## Individual and group runs of a master with three buttons on a BLE radio button

If you wish to control both the group and the master individually on a BLE radio button, proceed as follows:

- Combine devices in one group
- In the settings "Switch" the first button on Controls an element - here the "Up" or "Down" toggle switch of the master must be used
- Do the same with the second button for the other direction
- Select a third button as "Controls an element" and here the toggle switch of the master is used as an element

**Now you can switch back and forth between individual and group trips with the third button, which is configured on the toggle switch "Master".**

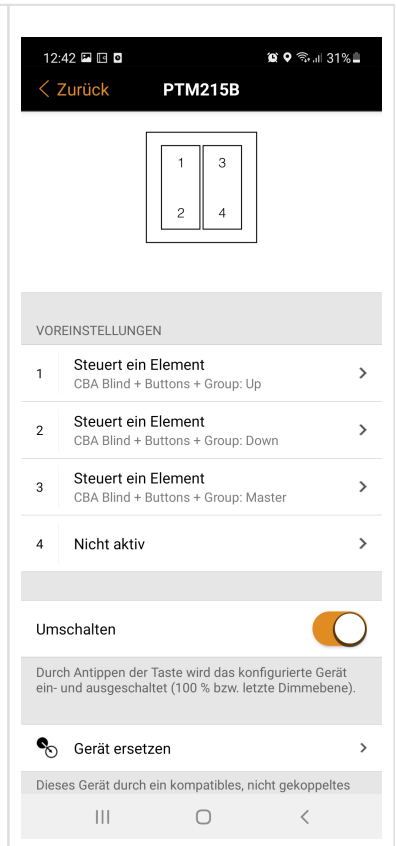

### NOTE



Since the BLE wireless buttons have no LED, you have no feedback whether the toggle switch "Master" is currently active, you would have to look in the app or try.

With the CTS2 module, a convenient function with visual feedback is possible through a built-in LED. Thus, you always know by a light LED whether an individual or group ride is set.

## Single runs of the master with two buttons on a BLE radio button:

If a blind actuator is defined as a master and you want to program a single trip via a BLE radio button, you have a hurdle to overcome. Since the toggle switch "Master" is active on a device that is configured as a master, a scene must be created for the single trip, in which it is deactivated first.

In order to steer the group again after a single trip, the "Master" toggle switch must be active again at the end of the run. To overcome this hurdle, several scenes and an animation have to be created, as explained by the following example:

<p>Create a scene for a drive "UP" or "DOWN"</p> <ul style="list-style-type: none"> <li>• Create new scene</li> <li>• Activate toggle switch for direction and deactivate toggle switch "master" at the same time</li> <li>• By activating the scene, the position is driven once up to 100% or 0% (it can also not be stopped; once the drive time ends, the toggle switch of the run is automatically deactivated again)</li> <li>• Create another scene where only the toggle switch "Master" is active</li> </ul>		
<ul style="list-style-type: none"> <li>• With the two created scenes, an animation is now created (<b>IMPORTANT is that the time for the scene of the run must be shorter than the set drive time</b>).</li> </ul>		

- |  |  |  |
|--|--|--|
| <ul style="list-style-type: none"><li>• Select the BLE wireless switch under the "Switch" function</li><li>• Control the scene- select the animation for the run here</li><li>• Then you have a Button for a run "up" or "Down", proceed the same way for the opposite direction</li></ul> |  |  |
|--|--|--|

## NOTE







In the case of individual operation with two buttons, there is currently the restriction that a fixed position is approached via a scene and cannot be stopped in between.

**Please note for animations with Toggle Switch:**

The scene or animation ends when the drive time expires. If animations are used, the animation must be at least 1 second shorter than the drive time.

## 7.6 Operation with Device button

The device-button has the same priority as the Casambi App, the last one wins.

Switching pattern *	Function	LED	
Relais ▲	UP		green
Relais ▲	STOP		OFF
Relais ▼	DOWN		red
Relais ▼	STOP		OFF

\* Short press on the device-button

## 7.7 Push-button mode

### Parameter Push-button mode

Through the parameter Push-button mode the functionality of the button inputs are defined.

To change the Push-button mode, proceed as shown below

1. Open the Casambi App
2. Double tap on the device icon
3. Scroll down to parameter
4. Tap on Push-button mode
5. Choose parameter  
(refer to following list)

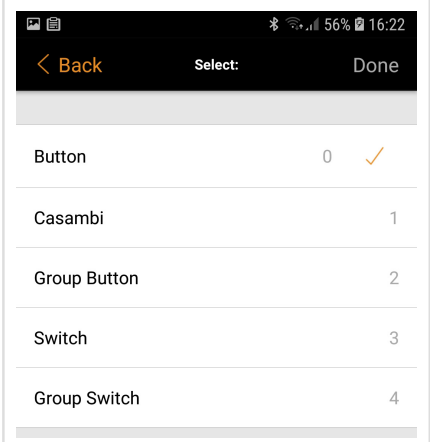

Push-button mode	Value	English
Button	0	Function as a push button  Press/hold button = drive; release button = stop
Casambi	1 *	Standard Casambi push-button-input (= Behavior like a standard Casambi push-button)
Group Button	2	Function as group button - push=drive; release=stop  If several blind actuators are combined as a group, one device of the group must be defined as the master. For the desired master, the push button style must be set to Group Button.  The other maintronic devices in the group are automatically slaves and the function of the master takes place.
Switch	3	Function as a switch  Press button (short) = drive; press button again (short) = stop Release is ignored
Group Switch	4	Function as a group switch - 1x push = drive; 1x push = stop  If several blind actuators are combined as a group, one device of the group must be defined as the master. For the desired master, the push button style must be set to Group Switch.  The other maintronic devices in the group are automatically slaves and the function of the master takes place.

\* = Default

#### NOTE



If a mode other than Casambi is selected as the Push-button mode, then the configuration of buttons in the app under switches has no function.



## 7.8 Programming timers

A timer needs a scene, to do this, configure as follows:

1. Open Casambi app and select a network
2. Create a scene for a drive
3. to create a timer go to the menu item "Timer"
4. Create new timer > edit > + add Timer
5. Select start time "Turns ON"
6. End time "Turns OFF" is not necessary
7. Add scene
8. Save timer with "DONE"
9. Proceed the same way for driving in the other direction

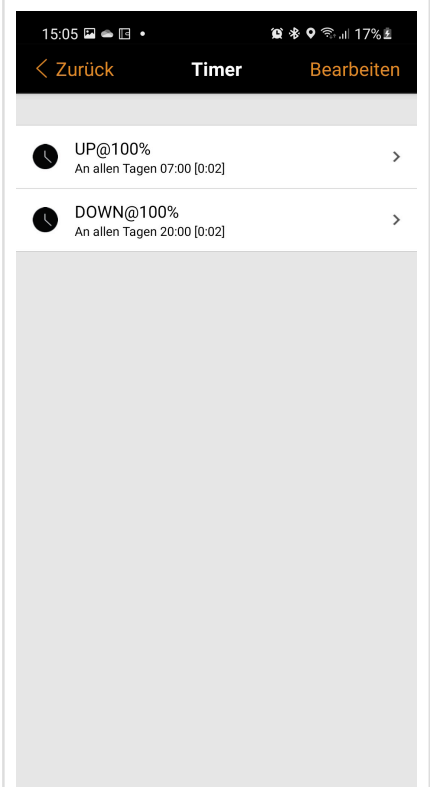
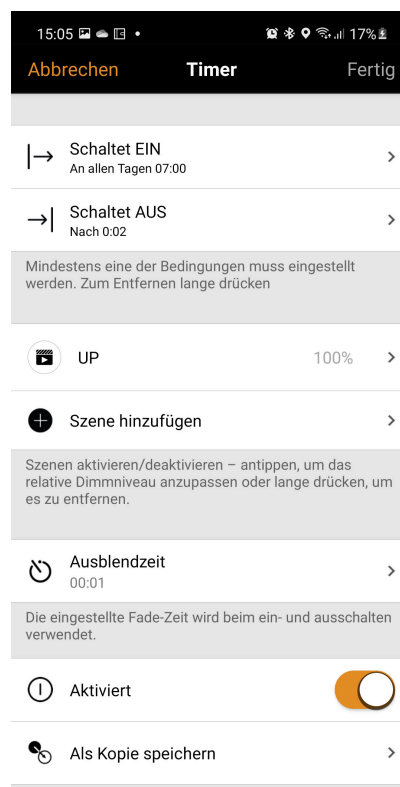

### NOTE



#### It is to be noted!

If the function "control hierarchy" is to be used, the scene is no longer deactivated after drive time.

The toggle switch also remains in the activated state.

If a manual drive is started during the day and night timeout, the problem occurs that after the timeout has expired, it may be automatically driven in the other direction again.

#### Explanation:

A manual drive only remains active until the timeout of the manual control is reached. This means that the timeout has elapsed, the control falls back to the automation and the blind moves to the position of the set timer.

### Ways to work around the control hierarchy issue:

- Using fixture buttons or ...
- Double click on the device → scroll to "Manual control" → set the parameter to "Timeout, if automation waiting"
- program scene with toggle switch
- Deactivate scene in THE timer after the desired drive time has elapsed "Turns OFF" (Turns OFF time must be greater than drive time)



## 8. Troubleshooting . CBA UP

### 8.1 Failure causes and solutions

#### Faulty group drives

##### Group drive command responds only the single device

Please check if the toggle switch master is activated on the desired device.

##### Not all blind actuators respond during a group drive

It could be possible that there are several masters defined in the group.

Please make sure that only the master is configured with a fixture "... Group".

##### Timer does not completely finish with animations

Please check if the drive time of the devices is longer than the set Drive time of the animation.

### 8.2 Unpair devices from network

#### Unpair a device from an existing network

A device that is integrated into a Casambi network can be removed from the network again with the function "unpair device".

Ein Gerät, dass in ein Casambi Netzwerk eingebunden ist, kann über die Funktion Gerät entkoppeln wieder aus dem Netzwerk entfernt werden.

1. Devices nearby
2. Select device
3. Unpair device

A successful unpairing is indicated in the app.

By unpairing from a network, the parameters and settings of the device are removed.

#### Unpair device from a network to which you no longer have access

To unpair a device to which you have physical access to from a network, you can use the function flick-unpairing.

To do this, the function "Allow flick-unpairing" must be activated.

1. Settings
2. Performance and safety
3. Activate "Allow flick-unpairing"

If the function is activated, proceed as follows to unpair the device from the network:

1. Devices nearby
2. Select device
3. Choose flick-unpairing

Either switch the device on and off for the duration of the unpairing or briefly disconnect the voltage.

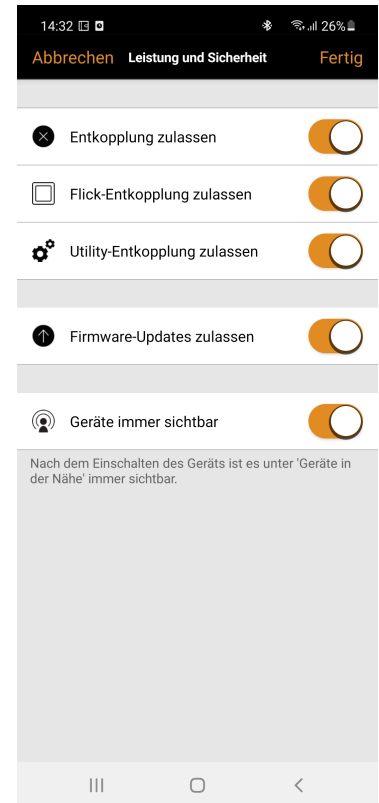

## Unpair device from a network when flick-unpairing is disabled

In the case that you no longer have access to the network and the security option "flick-unpairing" is disabled, the device must be unpaired with the utility app and thus removed from the network.

## Security option flick-unpair and allow utility pairing disabled

If all network security options such as "Allow unpairing", "Allow flick-unpairing" and "Allow utility unpairing" are disabled and you have no access to the network, then the only option is to contact the network admin and to log into the network.

### NOTE



Without access to the network, there is no way of making changes to the device or removing it from a network.

## 9. Service and maintenance . CBA UP